



# **APS 5 Battery Pack**

## **Manual**

# Content

Specifications

Description

Package Contents

Precautions

Recommendations for Battery Use

Battery Charging

Legal Compliances and Disclaimers

# Specifications

## APS 5

<b>Model</b>	<b>APS 5</b>
SKU	79181
Type	Li-ion
Nominal capacity at +22°C (72°F)	4900 mAh
Rated voltage	3.7 V
Charge/discharge cycles, minimum*	500
Charge/discharge ambient temperature	0°C...+35°C/-25°C...+50°C (+32°F...+95°F/-13°F...+122°F)
Dimensions	84 × 25 × 25 mm (3.3 × 1 × 1 inches)
Weight	0.08 kg (2.9 oz)

\* Once reached the specified limit, the battery capacity may drop to 80%. This is normal and not a defect.



# Description

**APS 5** rechargeable lithium-ion power supplies are designed for use with Pulsar thermal imaging devices.

**APS 5** batteries support USB Power Delivery fast charging technology when using a standard charging set (charger, USB Type-C cable, power adapter).

The rechargeable battery can be used separately, with a battery-locking cover (for Axion XQ/LRF XQ, Axion 2, Proton devices), or an adapter (for Talion devices).

# Package Contents

- APS 5 battery
- APS 5 battery-locking cover
- Adapter for Talions
- Operating Manual
- Warranty card

# Precautions

- Always use the APS 5 charger supplied with the device (or purchased separately) to charge APS 5 batteries. Using the unsuitable charger can cause irreparable damage to the battery and fire.
- Do not charge the battery immediately after bringing it from cold to warm. Wait at least 30 minutes for the battery to warm up.
- Do not leave the battery unattended while charging.
- Do not use the charger if it has been modified or damaged.
- Do not leave the battery in a charger connected to the network after charging is complete.
- Do not expose the battery to high temperatures and naked flame.
- Do not use the battery as a power source for devices that do not support APS 5 batteries.
- Do not disassemble or deform the battery.
- Do not drop or strike the battery.
- Do not submerge the battery.
- Keep the battery out of the reach of children.

# Recommendations for Battery Use

- The battery should be partially charged for long-term storage – 50 to 80 %.
- The battery should be charged at an ambient temperature of 0°C...+35°C (+32°F...+95°F). Otherwise, lifespan of the battery will decrease significantly.
- When using the battery at sub-zero temperatures, the battery capacity decreases, this is normal and not a defect.
- Do not use the battery at temperatures outside the range of -25°C...+50°C (-13°F...+122°F) – this may reduce battery's life.
- The battery has a short-circuit protection. However, any situation that may cause short-circuiting should be avoided.





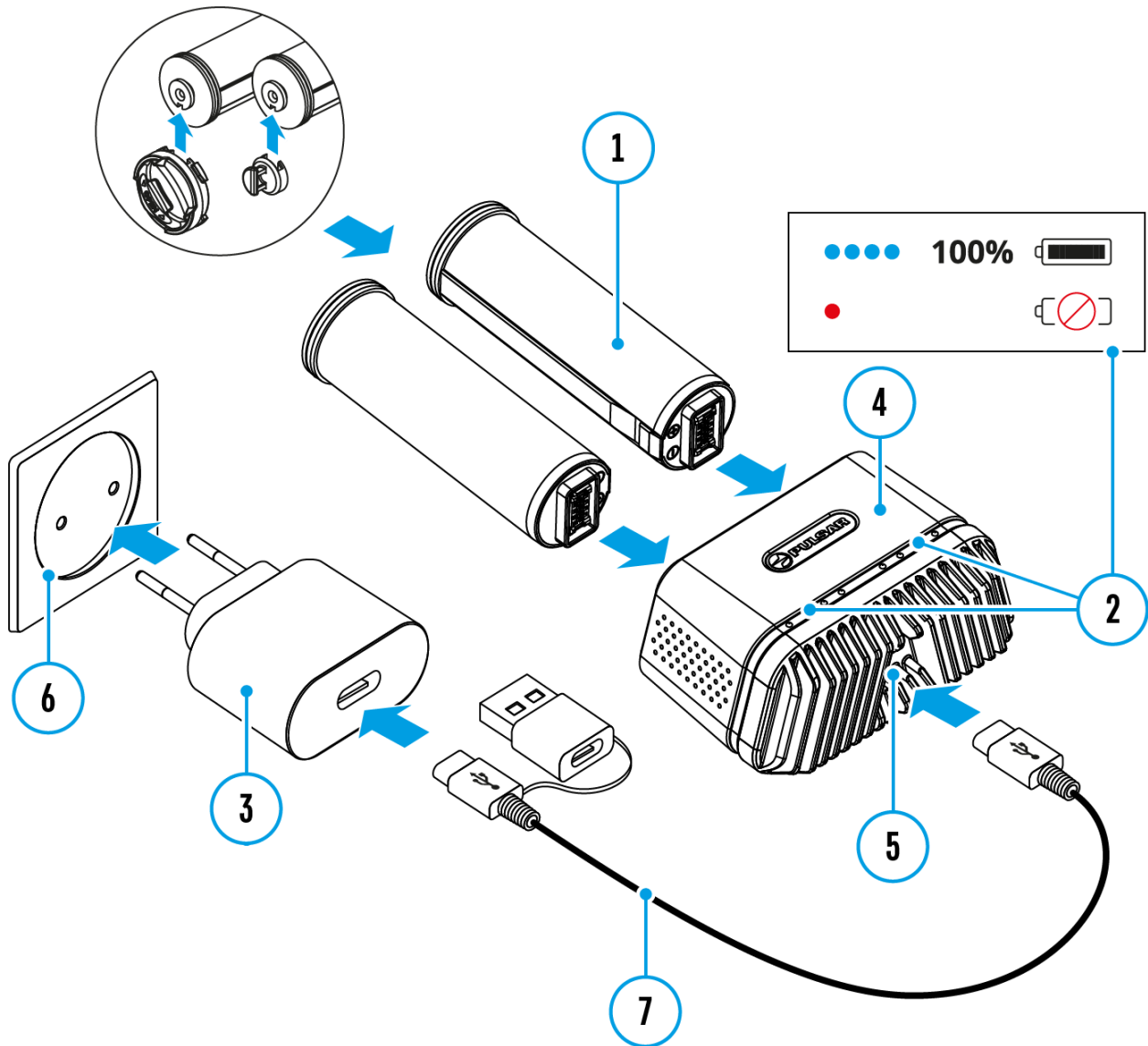



# Battery Charging







1. Insert the battery **(1)** along the guide to the stop into the APS 5\* charger slot **(4)** (see. Fig.).
2. Connect the plug of the USB Type-C cable\* **(7)** to the USB Type-C connector of the power adapter\***(3)**. Plug the power adapter **(3)** into a socket 100-240 V (110 V for US) **(6)**.
3. Connect the other end of the USB Type-C cable to the USB Type-C connector**(5)** of the charger **(4)** by removing the USB Type-A adapter.
4. LED indication**(2)** will display battery charge level (see Table).
5. Two batteries can be charged at the same time: the second slot is

designed for it.

LED indication (2) in the battery charging mode	Battery Level
	Battery charge level is from 0% to 25%
	Battery charge level is from 26% to 50%
	Battery charge level is from 51% to 80%
	Battery charge level is from 81% to 99%
	Battery is fully charged. Charging will automatically stop. The battery can be disconnected from the charger.
	Defective battery. <b>Do not use the battery!</b>

LED indication (2) in the standby mode**	Battery Level
	Battery charge level is from 0% to 25%
	Battery charge level is from 26% to 50%
	Battery charge level is from 51% to 80%
	Battery charge level is from 81% to 99%
	Battery is fully charged. It can be disconnected from the charger.

Defective battery. **Do not use the battery!**

---

**Attention!** When using a power adapter that does not support USB Power Delivery fast charging technology, the flicker frequency of LED indicators is reduced by 3 times.

**Attention!** The charger heats up during fast charging. Excess heat is removed through the radiator and does not affect the device operation.

\* Purchased separately or supplied as package contents of a device.

\*\* Standby mode - an operating mode in which batteries are inserted into the charger, but the power adapter is not connected. In this mode, the indication is on for 10 seconds.

# Legal Compliances and Disclaimers

The manufacturer reserves the right at any time, without mandatory notice, to make changes to the package contents, design and characteristics that do not impair the quality of the product.

Warranty for the Battery Pack is one year.

For technical support please contact [support@pulsar-vision.com](mailto:support@pulsar-vision.com).

Answers to frequently asked questions about the devices can also be found in the [FAQ](#) section.

